

home renovators **auktion**

Your dream kitchen at an affordable price!

KITCHENS

2015 / 2016

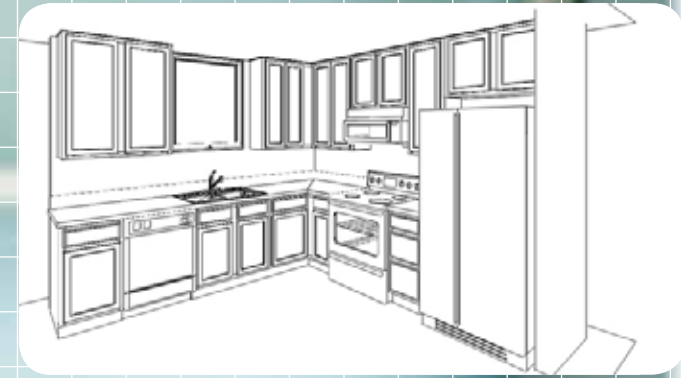



**A quality
kitchen of
your choice!**

Over the last twenty years Fowles Auctions & Sales have sold or auctioned thousands of kitchens to Victorian builders, property investors and home owners.

Our range of high quality kitchens include two pack doors, water resistant melamine internals and granite or reconstituted stone bench tops, all ready to install.

There are two easy ways to buy a kitchen from Fowles Auctions & Sales. You can attend the Home Renovator Auction on Wednesday at 10am and bid on one to take away that day or we can custom make one for you to suit your individual requirements.

The auction kitchens represent great value and are sold as per the layout with the doors and bench tops as displayed and there can be no changes or additions made.

Now due to huge demand we are providing kitchens custom made to suit your individual requirements at auction prices! Just provide us with your layout and we will provide you with a quote.

For a custom quote please contact Megan Marshall or Paul Vertigan on (03) 9265 5504

Hamilton MODEL No: AL 600 A

NOTES

- Comes in left or right
- Overhead cabinet layout can vary

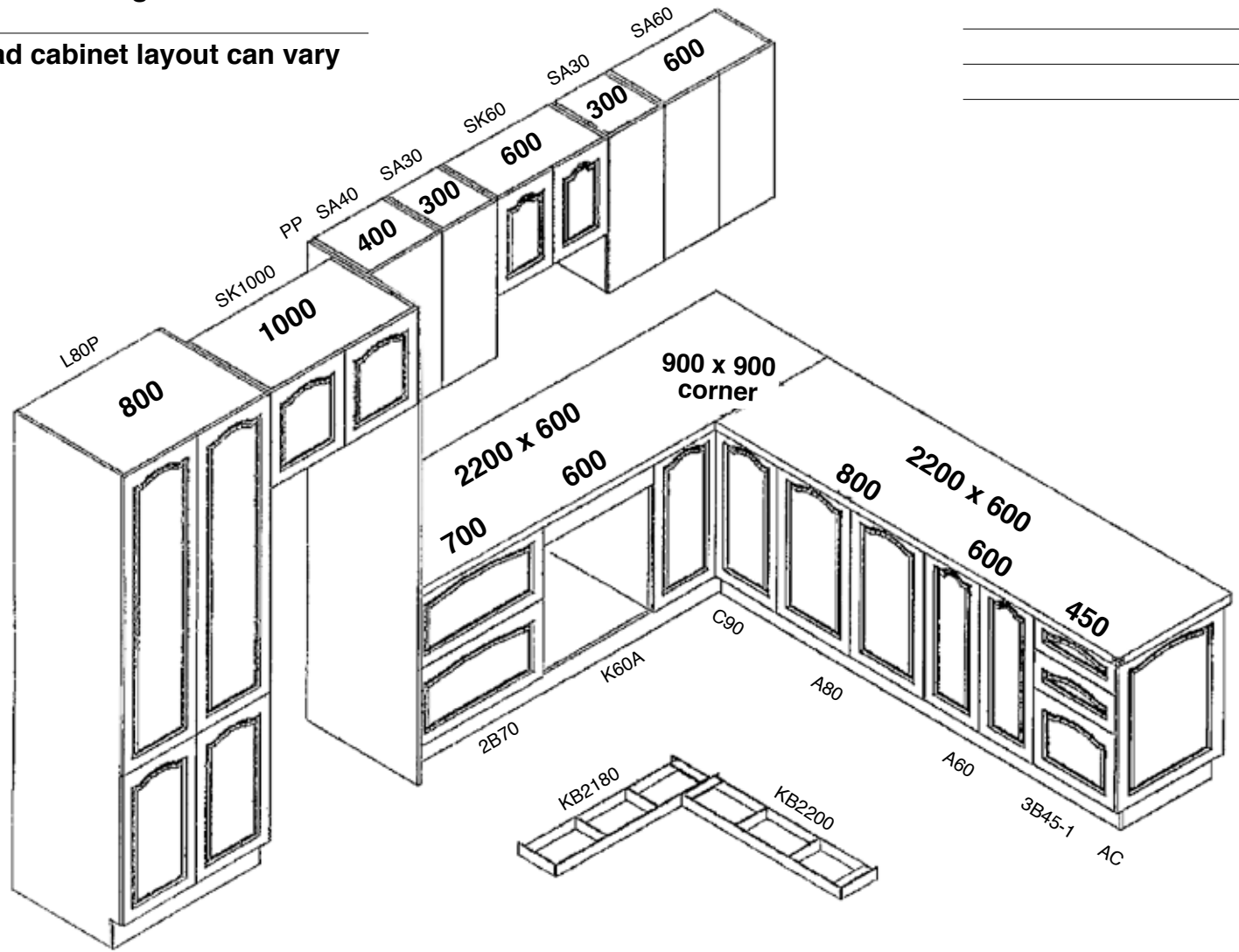

Hayman MODEL No: AU2

NOTES

- Comes in left or right
- Overhead cabinet layout can vary

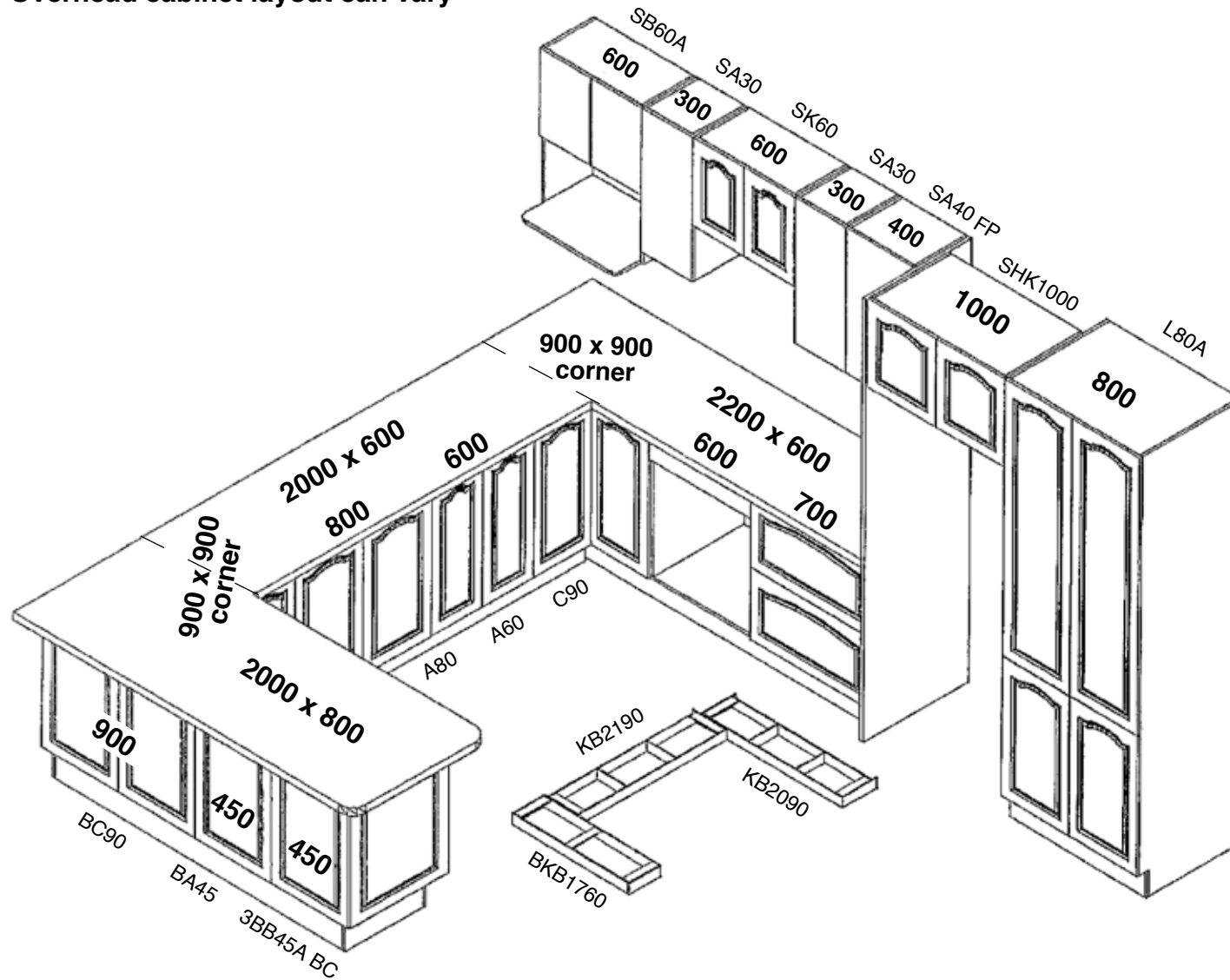

Lindeman MODEL No: BL

NOTES

- Comes in left or right
- Overhead cabinet layout can vary

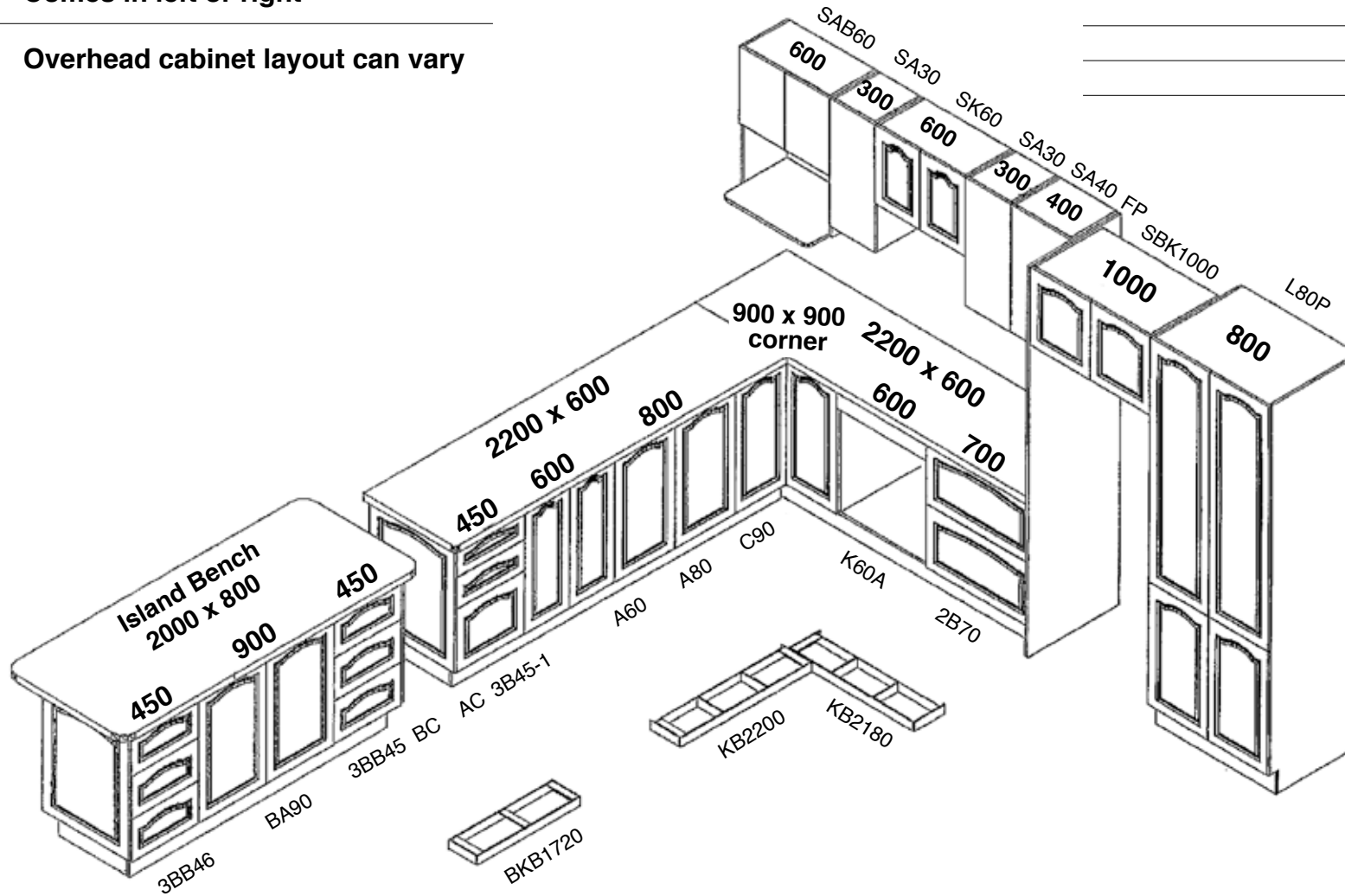

Nb: Island benches are fully finished edges on all sides

Bedarra MODEL No: CU2

- Comes in left or right
- Overhead cabinet layout can vary

NOTES

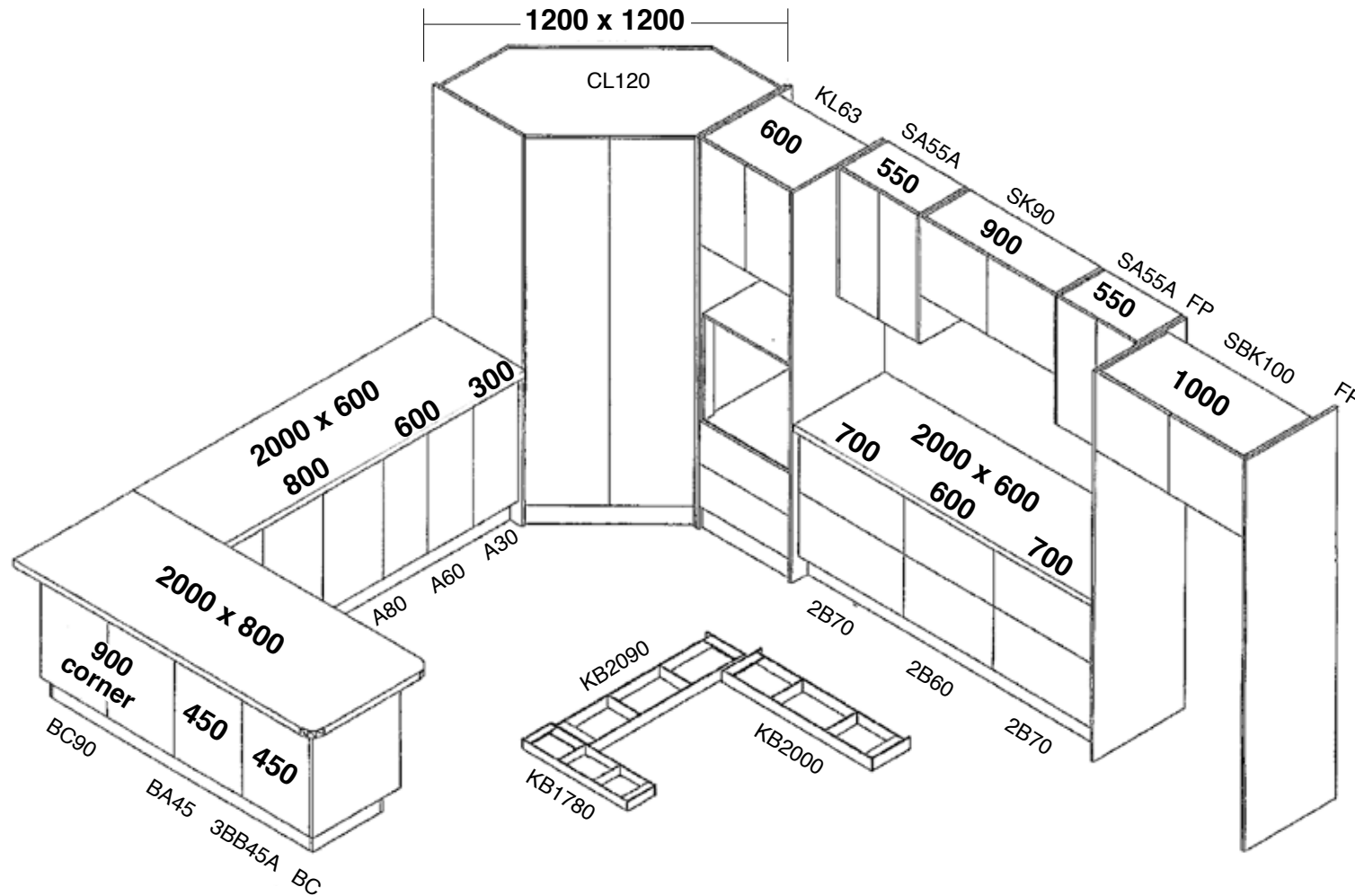

Custom designed kitchens

Design your own kitchen with our easy cut-out and plan on the next few pages. Let us know the finishing styles of cupboards and your benchtop choice, the email or fax us your plan and selections to -

Att: Paul Vertigan or Megan Marshall to receive a written quote within 24 hours or contact Megan or Paul on (03) 9265 5504

Name _____

Telephone/mobile _____

Fax No. _____

Email _____

Fax **03] 9265 5501** or

Email **sales@fowles.com.au**

Benchtop colours *You may want to visit our showroom to see samples. Tick your choice*

Black Galaxy Star White Star Grey Rose Pink HM Granite Butterfly Green Star Black

Benchtop profile



Square Edge

Cupboard profiles



Pencil Edge



Bevelled Edge



Square Routed



Colours and styles



Benchtop colours



Black Galaxy -
bronze fleck



Star White



Star Grey



Rose Pink

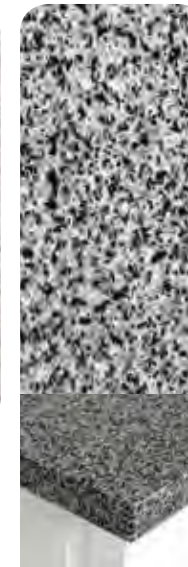

HM Granite

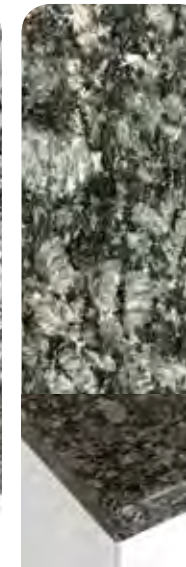

Butterfly Green

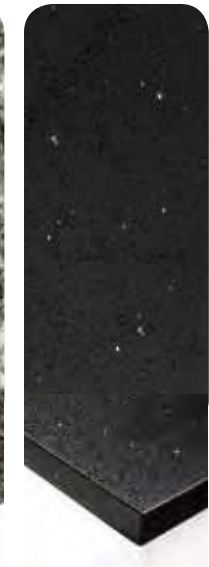

Star Black -
silver fleck

Benchtop profile



Square Edge

Cupboard profiles



Pencil Edge



Bevelled Edge



Square Routed

Base cabinets & cupboards

Plan it your way.. start here!

Here are our standard kitchen cabinet units you can use to configure the design you'd like. Measure the size of your space and determine the shape of the kitchen that best suits the area. Note the location of your windows, doors, plumbing, electricity and gas fittings. Then place the cupboards and utilities into a design that suits your needs. Remember the kitchen work flow triangle, whereby you can move from cooking to washing to storage easily. Be sure to have plenty of storage and benchtop space. Simply cut out the shapes and configure your design on the grid. Use what you need and what fits your floor plan and send it to us!

Fax **03] 9265 5501** or
 Email **sales@fowles.com.au**

Blind corner cabinet 900mm For tight spaces.

Oven cabinet 600 | 900mm Under bench.

Wine cupboard 150mm
 Can be used as floor or overhead cabinet.

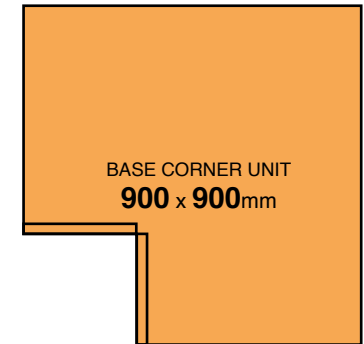
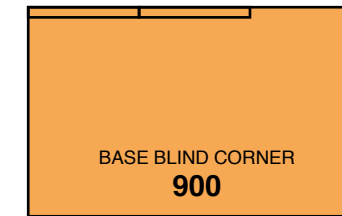
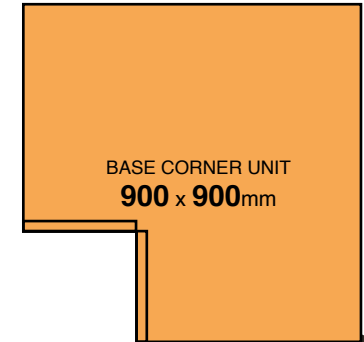
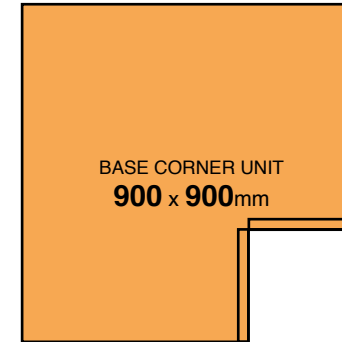
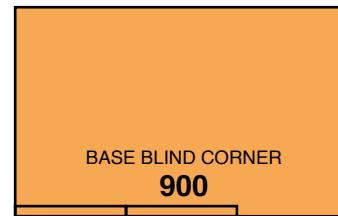
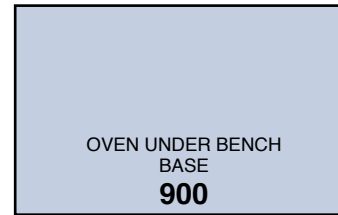
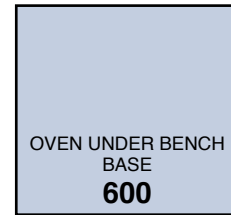

Base cupboards 150* | 250* | 300 | 350 | 400 | 450 | 600 | 700 | 800 | 900mm Scale: 1cm = 200mm



*Only available as a flat door profile

Need help? Call Megan Marshall or Paul Vertigan on (03) 9265 5504

Overhead cupboards

Rangehood cabinets 600 | 900mm
For slide out range hoods or fixed range hoods.

Wine cabinet 150mm
Used as floor or overhead cabinet

Microwave overhead 600mm
Shelf for microwave beneath cupboard

Corner open shelves unit 320 x 320mm

Refrigerator cabinet 800 | 900 | 1000mm

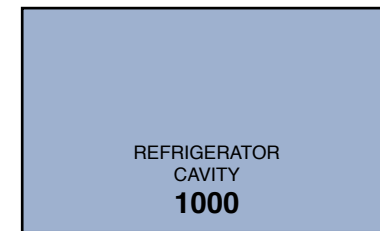
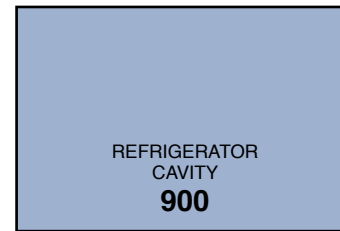
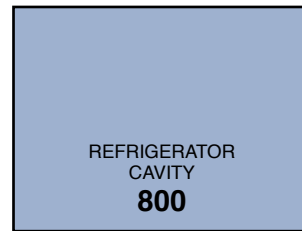
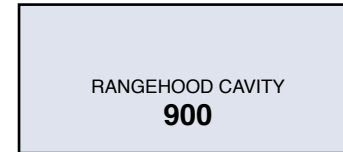
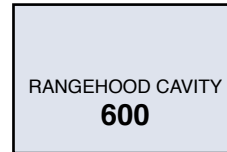

Overhead cupboards 150* | 250* | 300 | 350 | 400 | 450 | 600 | 700 | 800 | 900 Scale: 1cm = 200mm

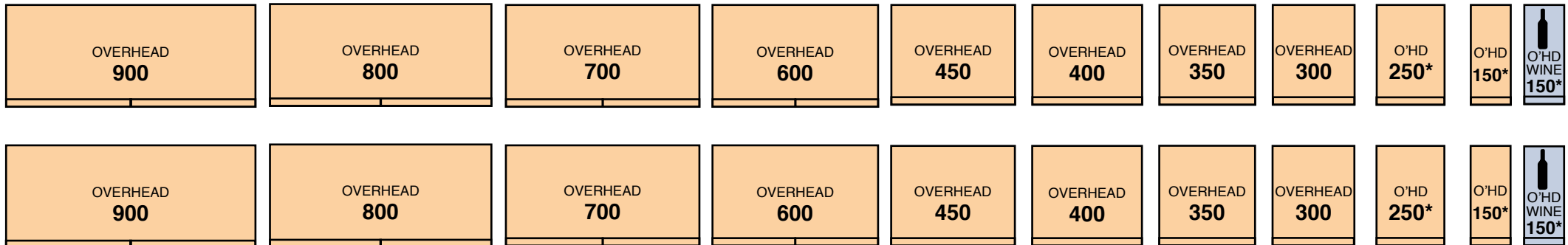

*Only available as a flat door profile

Need help? Call Megan Marshall or Paul Vertigan on (03) 9265 5504

Drawer cabinets & tall cupboards

2 equal drawers 600 | 700 | 800* | 900*mm

3 equal drawers 450 | 600 | 700mm

***Please note** 800mm and 900mm drawer cabinets only available in flat door profile. Square routed and bevelled are not available in the larger sizes.

Microwave cabinet 600mm 1 pot drawer Microwave shelf above drawer.

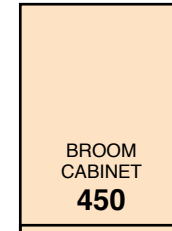
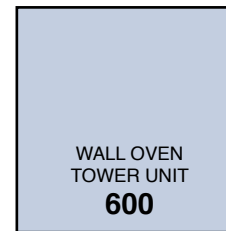
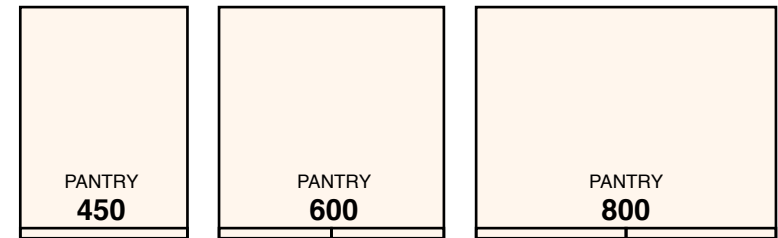

All tall cabinets have a finished height of 2230mm.

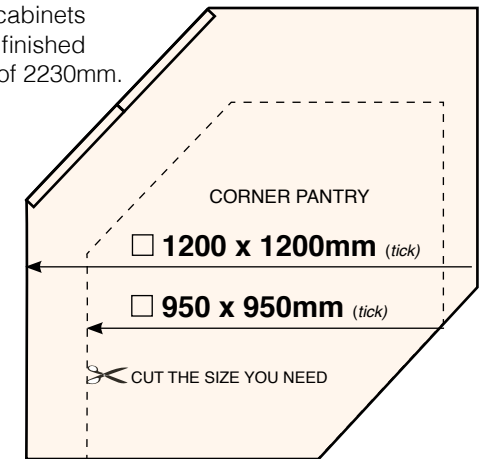

Base drawer cabinets 450 | 600 | 700 | 800 | 900mm Scale: 1cm = 200mm

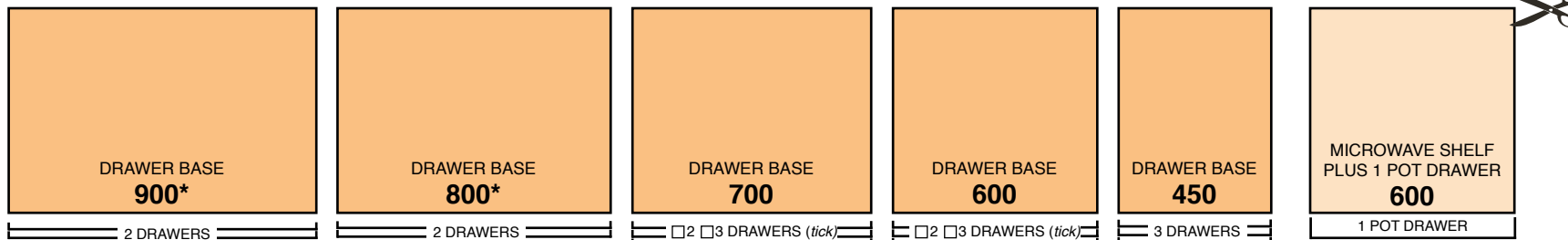
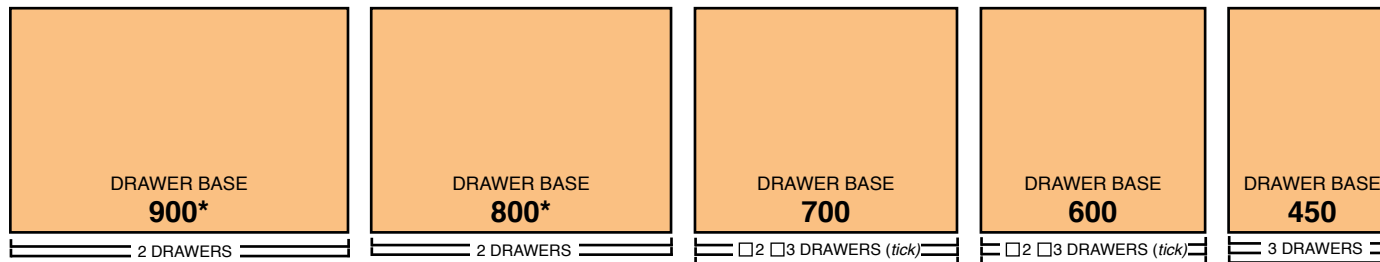

Need help? Call Megan Marshall or Paul Vertigan on (03) 9265 5504

Design your own kitchen

Simply cut out the shapes on the next page and configure your design on the grid.

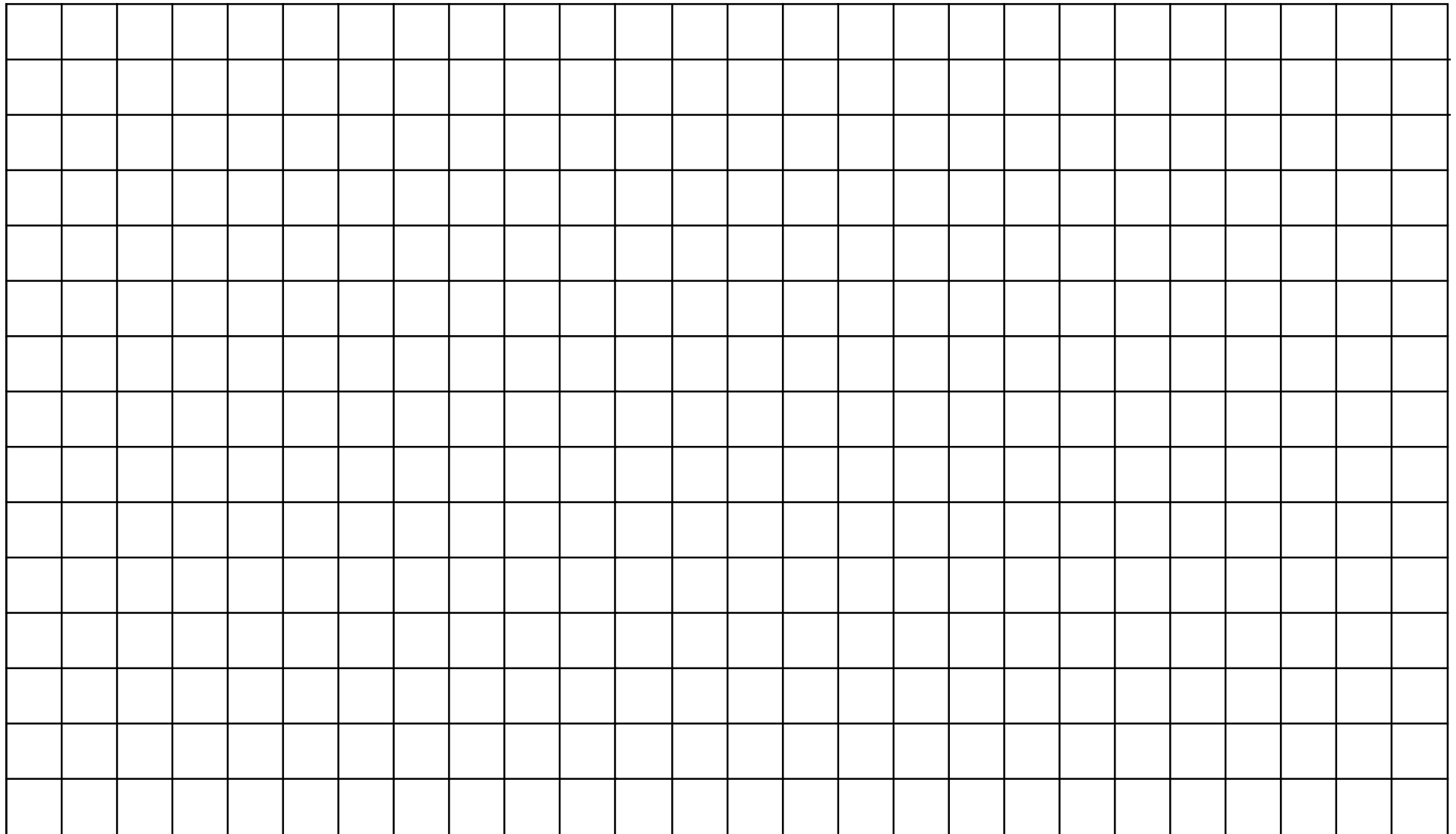

Fax: **03] 9265 5555** or email: **sales@fowles.com.au**

Scale: 1cm = 200mm

Att: Paul Vertigan or Megan Marshall to receive a written quote within 24 hours.



Our quote to you

A typical example

Here are a couple of sample kitchen layouts we have quoted for our customers.

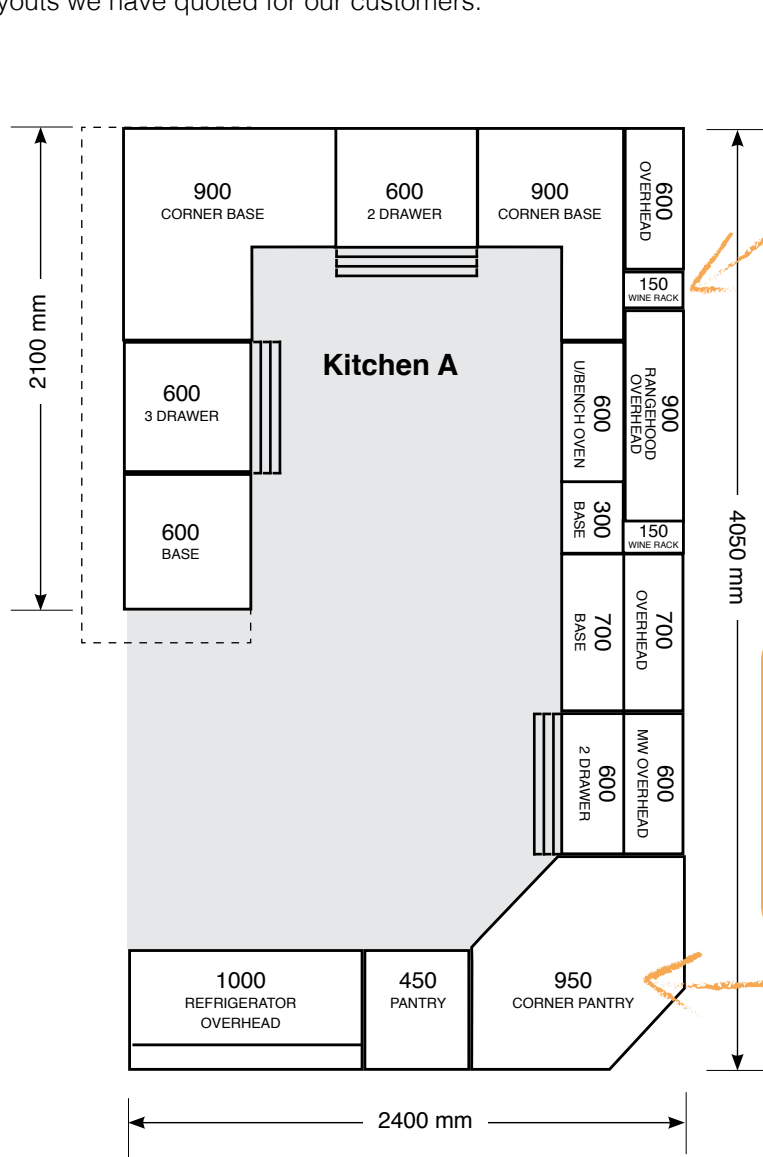

Wine rack units are handy and can be a base unit or overhead

A corner pantry will give you maximum functionality without using valuable benchtop space

Order your stone benchtops to 'waterfall' the ends of the bench for a stylish finish!

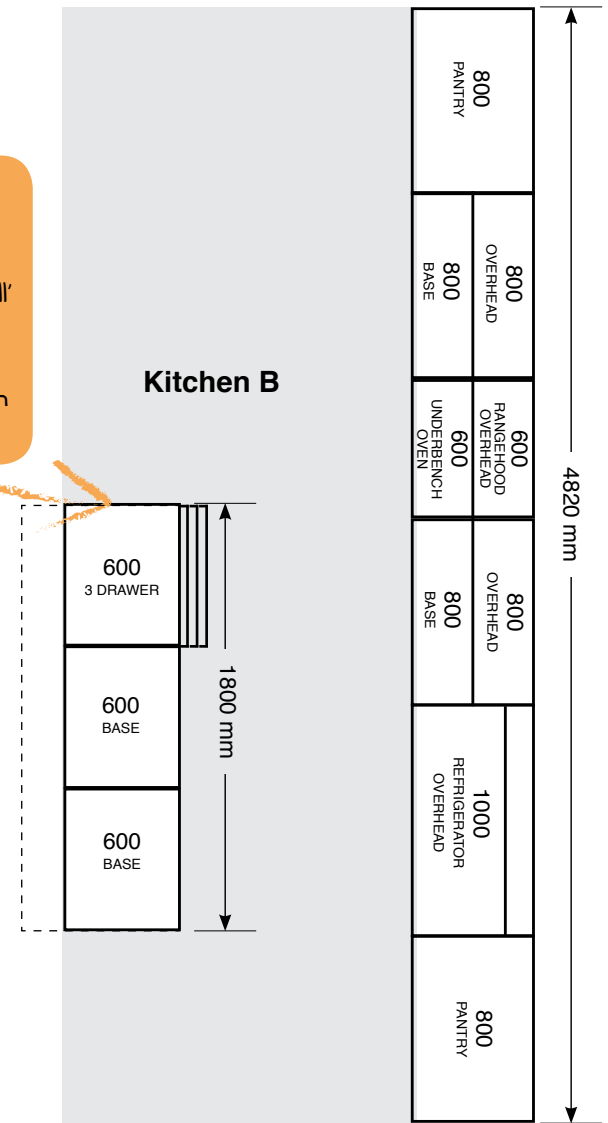

Need help? Call Megan Marshall or Paul Vertigan on (03) 9265 5504



Base cabinets, drawers & cupboards

Single door base cabinet
150 | 250 | 300 | 350 | 400 | 450mm

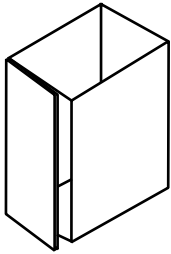

Note 150 and 250mm only available as a flat door profile

Two door base cabinet
600 | 700 | 800 | 900mm

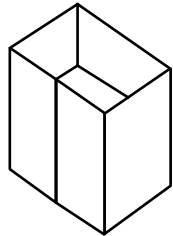

Two drawer base cabinet
600 | 700 | 800 | 900mm

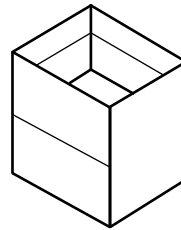

Note 800mm and 900mm drawer cabinets only available in flat door profile. Square routed and bevelled are not available in the larger sizes.

Three drawer base cabinet
450 | 600 | 700mm

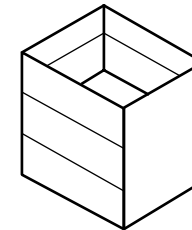

Corner base cabinet
900 x 900mm

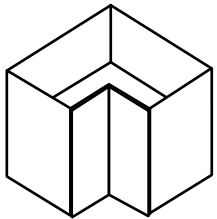

Blind corner two door
base cabinet
900mm

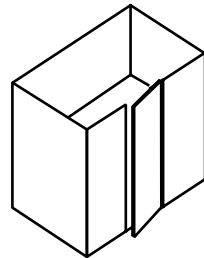

Under bench oven base
cabinet
600 | 900mm

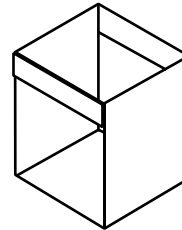

Under bench microwave &
single drawer base cabinet
600mm

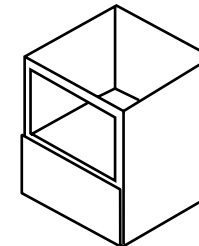

Wine rack for
base or overhead
150mm

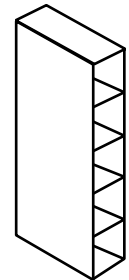

Need help? Call Megan Marshall or Paul Vertigan on (03) 9265 5504

Overhead cabinets & cupboards

Single door overhead cabinet
150 | 250 | 300 | 350 | 400 | 450mm

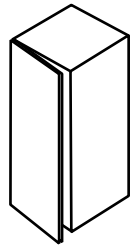

Note 150 and 250mm only available as a flat door profile

Two door overhead cabinet
600 | 700 | 800 | 900mm

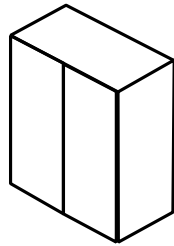

Rangehood overhead cabinet
600 | 900mm

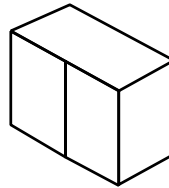

Refrigerator overhead cabinet
800mm 900 | 1000mm

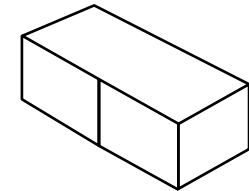
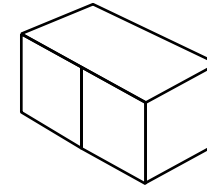

Corner overhead cabinet
600 x 600mm

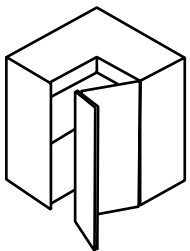

Microwave overhead cabinet
600mm

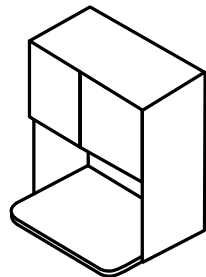

**Wine rack for
base or overhead**
150mm

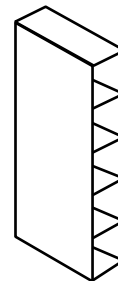

Corner overhead open shelf
320mm

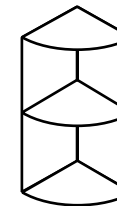

Need help? Call Megan Marshall or Paul Vertigan on (03) 9265 5504

Tall cupboards & pantries

All tall cabinets have a finished height of 2230mm

Single door pantry
450mm

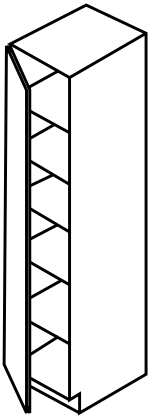

4 door pantry
600 | 800mm

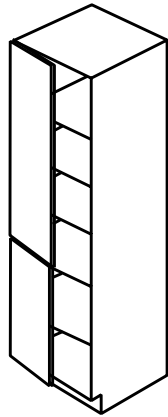

Wall oven and microwave with
2 drawers cabinet
600mm

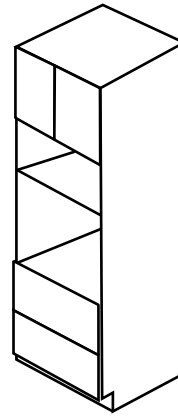

Broom cabinet
450mm

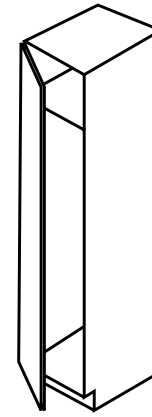

Single door corner pantry
950 x 950...mm

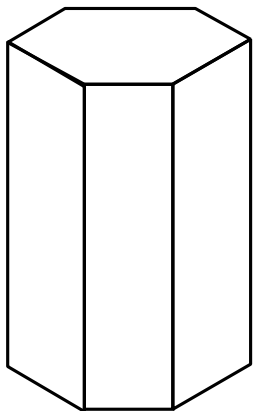

2 door corner pantry
1200 x 1200mm

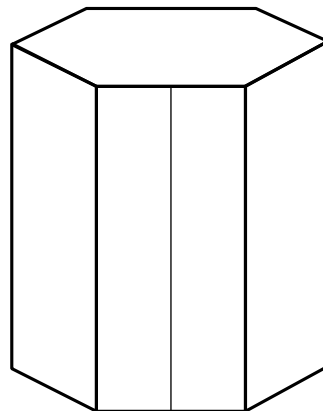

Need help? Call Megan Marshall or Paul Vertigan on (03) 9265 5504

Bargain prices for complete kitchens!



Payment

Your kitchen needs be paid in full before ordering. We accept cash, eftpos, bank cheque and credit card (Mastercard & Visa - 1% surcharge on all credit card purchases, Amex surcharge 3%).

We also accept direct deposit to: Fowles Auction & Sales

ANZ

BSB: 013 268

A/C: 8357 85088

Remitter information can be your surname

Pick up

Fowles Auctions & Sales have a list of experienced delivery transport companies; see helpful contacts on the next page. If you choose to pick the kitchen up by yourself please organise a day and time with either Megan or Paul. You will need 2 people to load the kitchen so please bring someone with you, and don't forget blankets to help pack around the kitchen cabinets.

Helpful contacts



When you organise your transport company to pick up your kitchen, make sure they send **2 people to load** as granite and kitchen cupboards are heavy and a 2 person lift. Due to OH&S responsibilities Fowles Auctions & sales staff will not be available to load your transportation, the driver will need to do this.

Transport companies

Tonner Transport

Contact Michael - 0408 395 927

Charles Hughes Furniture Removals

Contact Charles - 0408 561 738

Kitchen Installations

All Interior Installations

Ross - 0478 595 323

City to Coast

Mick - 0409 196 188

Stonemason

Gary from Bedrock City stonemason has had loads of experience installing the kitchens sold at the Home Renovator Auction at Fowles Auctions & Sales. Give him a call to discuss your plans.

Bedrock City

Gary Davis - 0412 055 304

or

RSM

Richie - 0479 182 119